

Euro Single Pole Lite

PROJECT:

TYPE:

SOURCE:

NOTES:

PURELED SPECIFICATIONS

LED Chip	Cree XHP-50-2 Plug and Play field replaceable LED board
Luminaire Output	420 Lumens @ 700mA (4 watts), 240 Lumens @ 350mA (2 watts), delivered from luminaire with unobstructed beam.
Lumens Per Watt	105 Lumens minimum @ 4 watts, delivered from luminaire with unobstructed beam
CRI (3000K)	90+
Colour Temperatures	2700K, 3000K, 4000K
Beam Angles	15, 25, 38, 60
Ingress Protection	IP56/IP66

Warranty	Electronics = 5 years Body Cop/ SS = 10 years
Standards	AS/NZS 61046 cUL 1838, 2108 CSA C22.2 No. 250.7, No. 250.0-08 CE

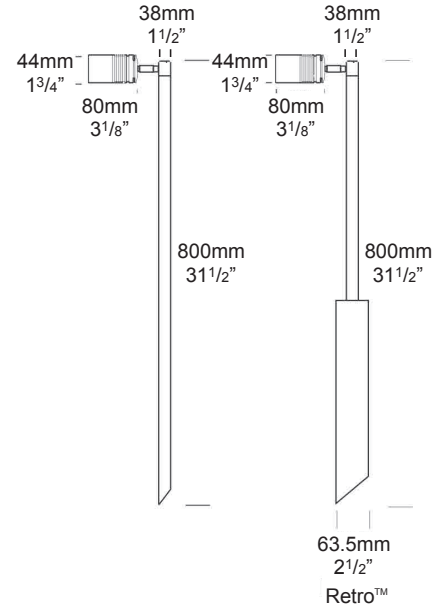

PRODUCT CONFIGURATION

Please fill in appropriate codes into boxes provided

Cat. No. ESPL/L

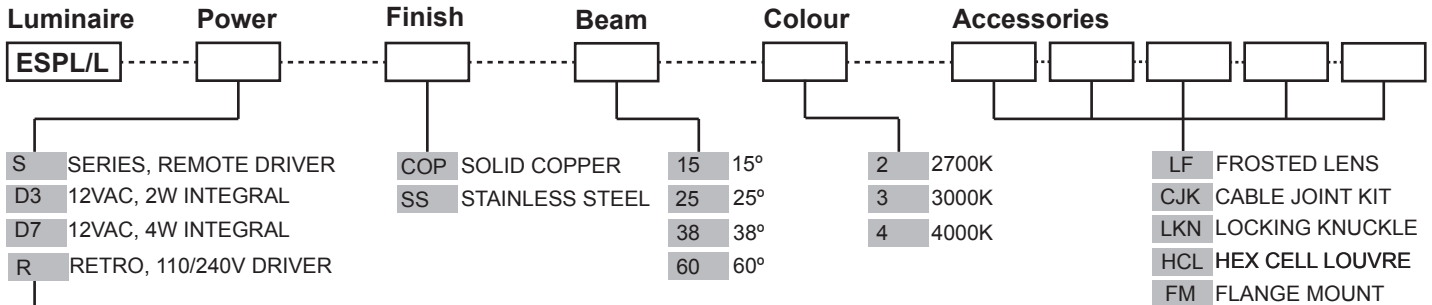

SERIES, REMOTE DRIVER REQUIRED:
Constant current driver
Individual fixtures require 6vdc @ 700mA maximum

12VAC INTEGRAL DRIVER:
Hunza integrated Plug and Play Driver (included)
Input: 12VAC, 5watt total.
Output: 6vdc @ D3=350mA, D7=700mA

110/240VAC RETRO DRIVER:
Input: 120/240vac, 5 watt total (included)
Output: 6vdc, 700mA
0-10 volt dimming
(USA - non dimming)

OTHER LAMP OPTIONS:

ESPL/H - MR11 Halogen 12V Lamp
ESPL/M11L - MR11 LED Retrofit 12V Lamp (lamps vary by market - please refer to supplier for details)

[Click here for halogen specification sheet](#)

[Click here for 240v Remote Power Supply Guidance Charts](#)

[Click here for USA Remote Power Supply Guidance Charts](#)

LUMINAIRE CONSTRUCTION

CNC machined from one of the following metals:

Copper:

Body: 45.4mm (1^{3/4}") copper rod.
Pole: 38mm (1^{1/2}") copper tube.

316 Stainless Steel

Body: 45.4mm (1^{3/4}") stainless steel rod.
Pole: 38mm (1^{1/2}") stainless steel tube.

Lens:

6mm (1/4") extra clear low iron flush fit shatter resistant glass.
Lifetime Warranty.

Knuckles:

Copper luminaires: 360° rotation and 0-90° elevation, solid brass with anti rust spring.
Stainless Steel luminaires: 360° rotation and 0-90° elevation, full stainless steel construction.

Gaskets:

Silicone, iron impregnated 220°C (428°F)

Mounting:

The pole 850mm (33^{1/2}") is directly mounted into the earth. A Flange Mount option is available for mounting onto hard surfaces. Retro™ version is set into concrete.

Luminaire Weight:

Low Voltage
Cop: 1.900kg (4lb 3oz)
SS: 1.550kg (3lb 7oz)
Retro™
Cop: 2.800kg (6lb 3oz)
SS: 2.600kg (5lb 12oz)

ACCESSORIES

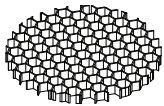

Hex Cell Louvre

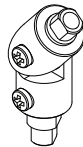

Locking Knuckle

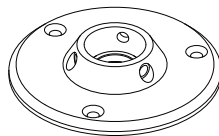

Flange Mount

BEAM ANGLES

High efficiency PMMA TIR lenses. Field replaceable

IES files available for download: hunzalighting.com/downloads

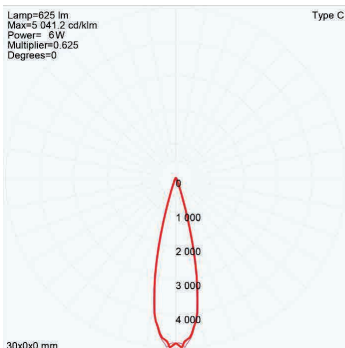

15° FWHM TIR

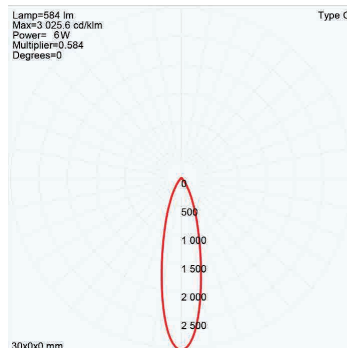

25° FWHM TIR

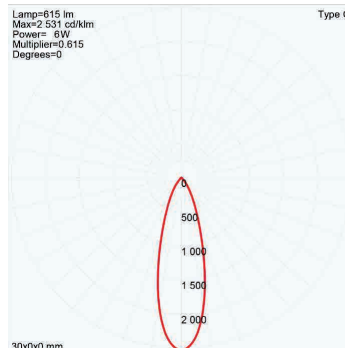

38° FWHM TIR

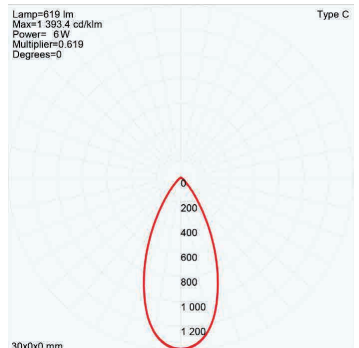

60° FWHM TIR

WIRING GUIDE

Series/remote driver

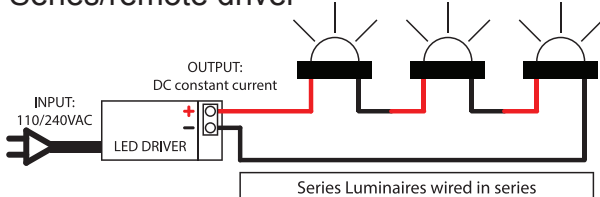

Series Luminaires wired in series

Available for download: hunzalighting.com/downloads

12v integral driver

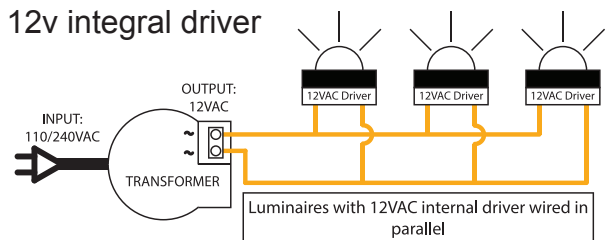

Luminaires with 12VAC internal driver wired in parallel

Diagrams are a guide only, wire colours and polarity may change depending on fixture and country

Specifications may change without notification

Aug 2017

HUNZA™ PURE OUTDOOR LIGHTING

HUNZA FACTORY 130 Felton Mathew Ave
Saint Johns
Auckland 1072
New Zealand

Ph: +64-9-528 9471
Fax: +64-9-528 9361
hunza@hunza.co.nz
www.hunzalighting.com

INTERNATIONAL CONTACTS:
<http://www.hunzalighting.com/contact.php>

This document contains proprietary information of Hunza. Its receipt or possession does not convey any rights to reproduce or disclose its content.