

## Euro Single Pole Lite

PROJECT: \_\_\_\_\_

TYPE: \_\_\_\_\_

SOURCE: \_\_\_\_\_

NOTES: \_\_\_\_\_

### PURELED SPECIFICATIONS

<b>LED Chip</b>	Cree XHP-50-2 Plug and Play field replaceable LED board
<b>Luminaire Output</b>	420 Lumens @ 700mA (4 watts), 240 Lumens @ 350mA (2 watts), delivered from luminaire with unobstructed beam.
<b>Lumens Per Watt</b>	105 Lumens minimum @ 4 watts, delivered from luminaire with unobstructed beam
<b>CRI (3000K)</b>	90+
<b>Colour Temperatures</b>	2700K, 3000K, 4000K
<b>Beam Angles</b>	15, 25, 38, 60
<b>Ingress Protection</b>	IP56/IP66

<b>Warranty</b>	Electronics = 5 years Body Cop/ SS = 10 years
<b>Standards</b>	AS/NZS 61046 cUL 1838, 2108 CSA C22.2 No. 250.7, No. 250.0-08 CE

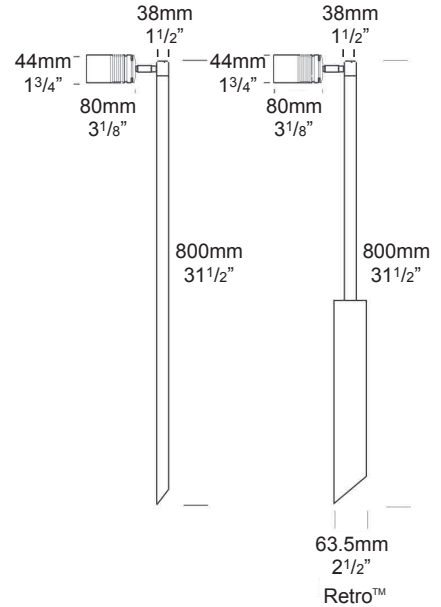

### PRODUCT CONFIGURATION

Please fill in appropriate codes into boxes provided

Cat. No. ESPL/L

Luminaire	Power	Material/ Finish	Beam	Colour	Accessories
ESPL/L	<input type="text"/>	<input type="text"/>	<input type="text"/>	<input type="text"/>	<input type="text"/>
S	700mA Input, Series Wired 4W	COP SOLID COPPER	15 15°	2 2700K	LF FROSTED LENS
D3	12VAC Input, Parallel Wired 2W	SS STAINLESS STEEL	25 25°	3 3000K	CJK CABLE JOINT KIT
D7	12VAC Input, Parallel Wired 4W		38 38°	4 4000K	LKN LOCKING KNUCKLE
D24	24VDC Input, Parallel Wired		60 60°		HCL HEX CELL LOUVRE
R	RETRO, 110/240V Input, Parallel Wired				FM FLANGE MOUNT

**SERIES, REMOTE DRIVER REQUIRED:**  
Constant current driver  
Individual fixtures require 6vdc @ 700mA maximum

**12VAC INTEGRAL DRIVER:**  
Hunza integrated Plug and Play Driver (included)  
Input: 12VAC, 5watt total.  
Output: 6vdc @ D3=350mA, D7=700mA

**110/240VAC RETRO DRIVER:**  
Input: 120/240vac, 5 watt total (driver included)  
Output: 6vdc, 700mA (non dimming)

**24VDC DRIVER:**  
Input: 24vdc.  
Output: 18vdc @ 700mA constant current (non dimming).  
*Note: not for USA.*

[Click here for 240v Remote Power Supply Guidance Charts](#)

[Click here for USA Remote Power Supply Guidance Charts](#)

# LUMINAIRE CONSTRUCTION

**CNC machined from one of the following metals:**

**Copper:**

Body: 45.4mm (1<sup>3/4</sup>" ) copper rod.  
Pole: 38mm (1<sup>1/2</sup>" ) copper tube.

**316 Stainless Steel**

Body: 45.4mm (1<sup>3/4</sup>" ) stainless steel rod.  
Pole: 38mm (1<sup>1/2</sup>" ) stainless steel tube.

**Lens:**

6mm (1/4" ) extra clear low iron flush fit shatter resistant glass.  
Lifetime Warranty.

**Knuckles:**

Copper luminaires: 360° rotation and 0-90° elevation, solid brass with anti rust spring.  
Stainless Steel luminaires: 360° rotation and 0-90° elevation, full stainless steel construction.

**Gaskets:**

Silicone, iron impregnated 220°C (428°F)

**Mounting:**

The pole 850mm (33<sup>1/2</sup>" ) is directly mounted into the earth. A Flange Mount option is available for mounting onto hard surfaces. Retro™ version is set into concrete.

**Luminaire Weight:**

Low Voltage  
Cop: 1.900kg (4lb 3oz)  
SS: 1.550kg (3lb 7oz)  
Retro™  
Cop: 2.800kg (6lb 3oz)  
SS: 2.600kg (5lb 12oz)

## ACCESSORIES

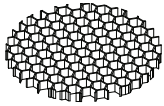

Hex Cell Louvre

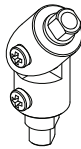

Locking Knuckle

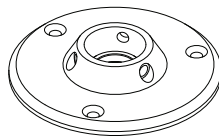

Flange Mount

## BEAM ANGLES

High efficiency PMMA TIR lenses. Field replaceable

IES files available for download: [hunzalighting.com/downloads](http://hunzalighting.com/downloads)

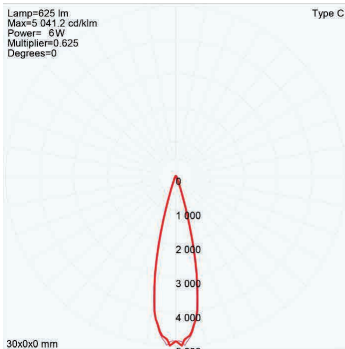

15° FWHM TIR

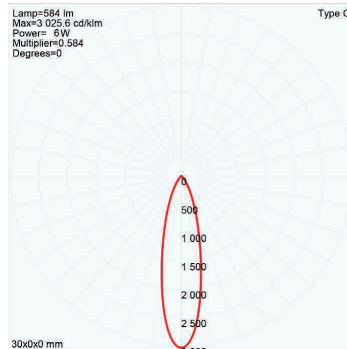

25° FWHM TIR

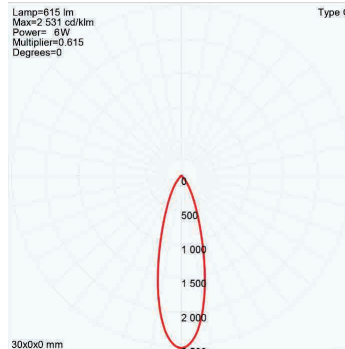

38° FWHM TIR

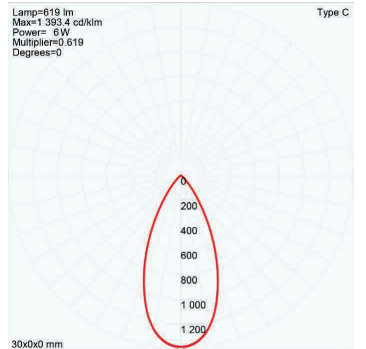

60° FWHM TIR

## WIRING GUIDE

Available for download: [hunzalighting.com/downloads](http://hunzalighting.com/downloads)

**Series/remote driver**

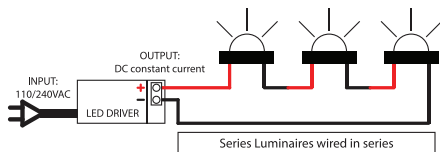

Diagrams are a guide only, wire colours and polarity may change depending on fixture and country

**110/240v integral driver**

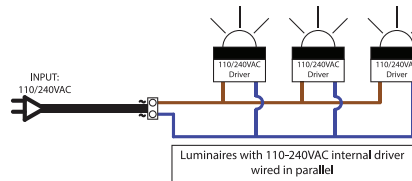

**12v integral driver**

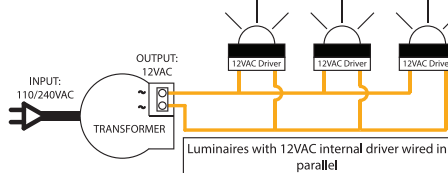

**24vdc integral driver**

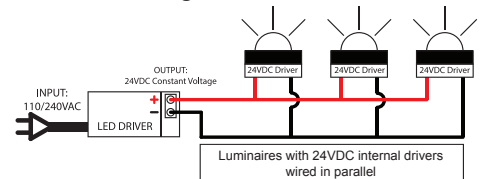

Specifications may change without notification

Aug 2017